



Юридический адрес: 344019, г. Ростов-на-Дону, пер. Краснофлотский, 22, оф.132, ИНН 6163059717, КПП 616701001, ОКПО: 55510030. р/с 40702810352000103147 к/с 30101810600000000602 в юго-западном банке СБ РФ г. Ростов-на-Дону. БИК: 046015602. Факт. адрес: Московская область, г. Люберцы, Октябрьский просп. д. 249, ИНН: 6163059717, КПП: 502732001, р/с 40702810540240103884 к/с 30101810400000000225 БИК: 044525225 ОАО СБЕРБАНК РОССИИ г. Москвы Тел (495)685-92-01, 685-95-93

Ваши консультанты по по алюминиевым охладителям:

(495) 685-92-01

(495) 685-95-93

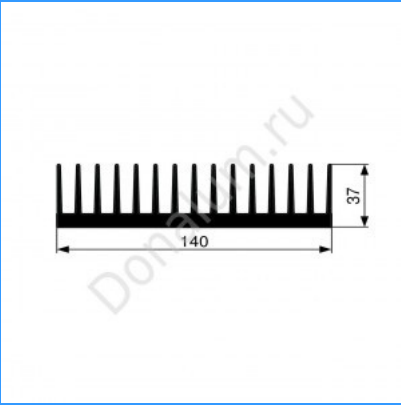
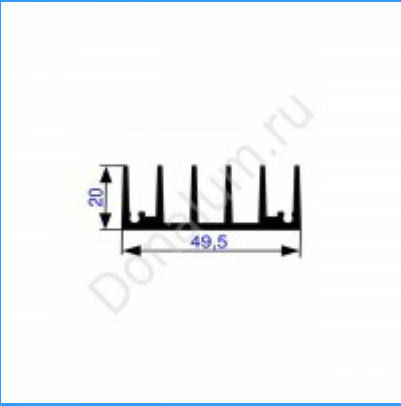

(495) 565-47-97

АЛЕКСАНДР РЕМИЗОВ	ведущий специалист направления	rinok3@donal.ru	моб.: +7 (929) 905-42-31
ЕВГЕНИЙ ГРОМОВ	специалист отдела продаж	potolok2@donal.ru	моб.: +7 (929) 659-55-05
АЛЕКСЕЙ СИМОНЕНКО	специалист отдела продаж	potolok1@donal.ru	моб.: +7 (925) 801-69-19
РОМАН СТРИЛЕЦ	специалист отдела продаж	pokupka@donal.ru	Моб.: +7 (926) 994-87-39

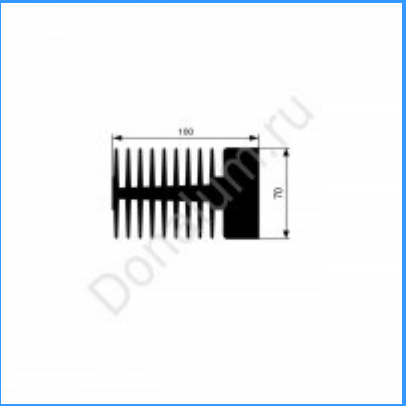
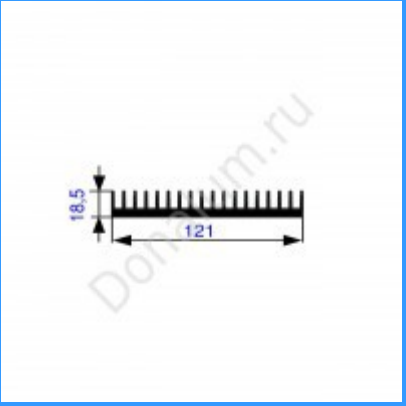
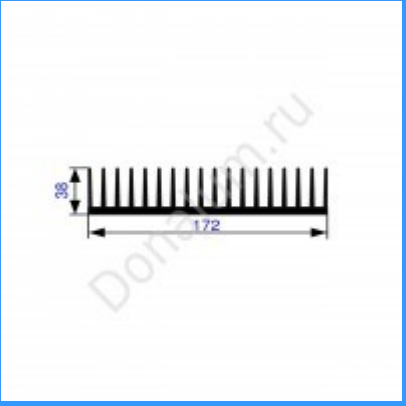
Артикул	Масса 1п.м., кг	Диаметр описанной окружности,мм	Профиль	Габаритные размеры
Гребенки				
1	5,656	146		37x140
2	0.79	52.3		20x49.5

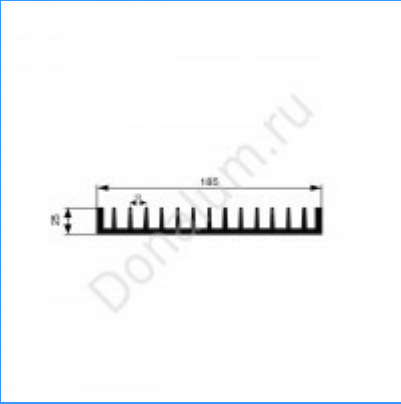
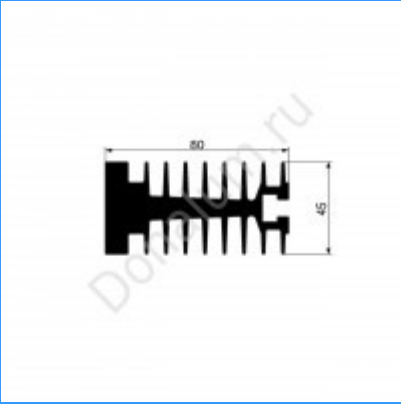
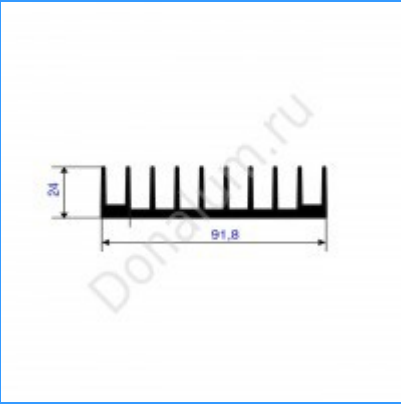
3	10.186	120	 <p>Technical drawing of a comb with 120 teeth. The width is 70 and the height is 100. The teeth are evenly spaced and extend to the top edge.</p>	70x100
4	2.818	122.3	 <p>Technical drawing of a comb with 122.3 teeth. The width is 18.5 and the height is 121. The teeth are evenly spaced and extend to the top edge.</p>	18.5x121
5	6,233	176	 <p>Technical drawing of a comb with 176 teeth. The width is 38 and the height is 172. The teeth are evenly spaced and extend to the top edge.</p>	38x172

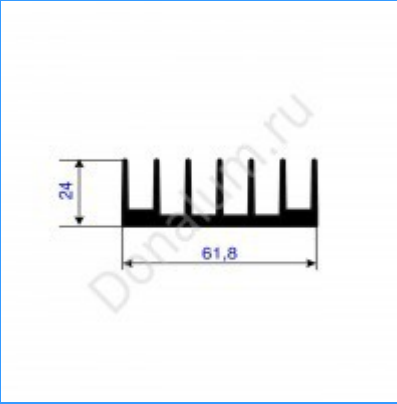
6	4.607	186.4		25x185
7	4.74	90		45x80
8	1.911	94.5		24x91.8

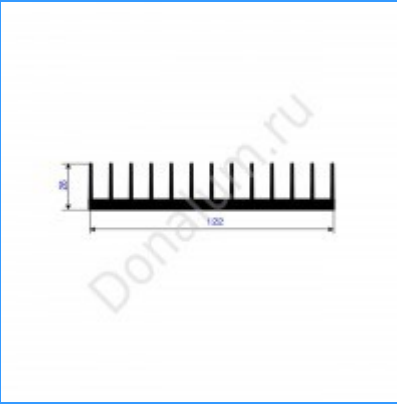
9	1.338	66		24x61.8
10	3.69	85		58x64
11	2.962	124.5		28x122

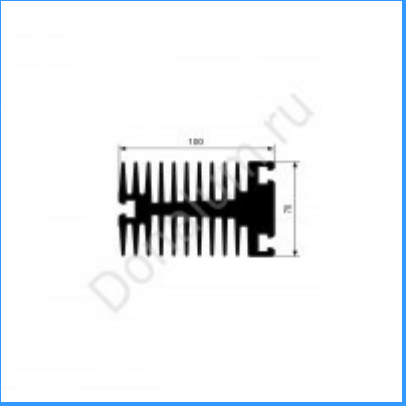
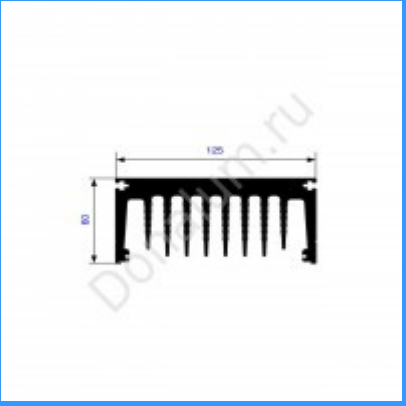
12	2.322	120.1		12x120
13	8.79	119		70x100
14	8.244	138.5		60x125

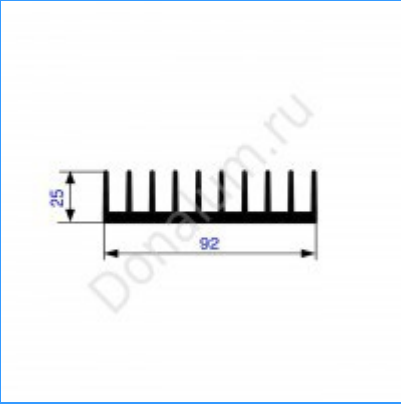
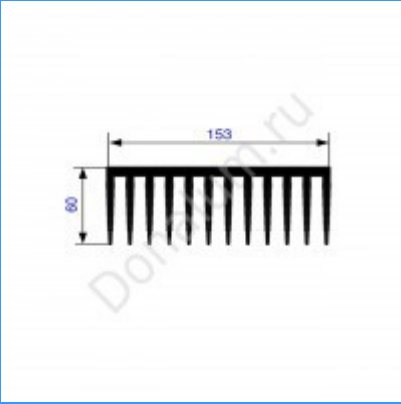
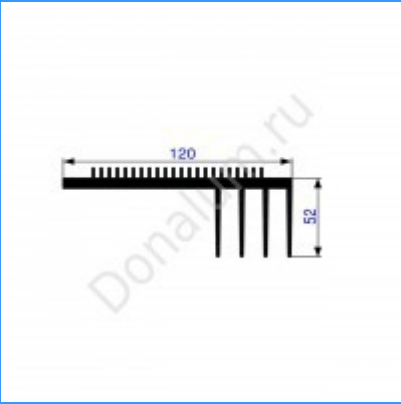
15	2.157	94.8		25x92
16	8.336	163		60x153
17	3.245	128		52x120

18

5.382

130.4

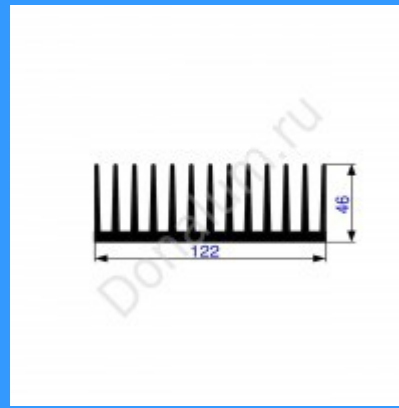

46x122

Охладители

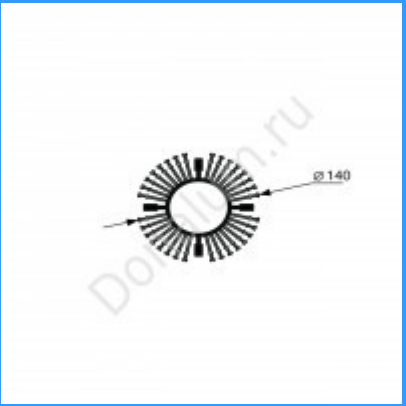
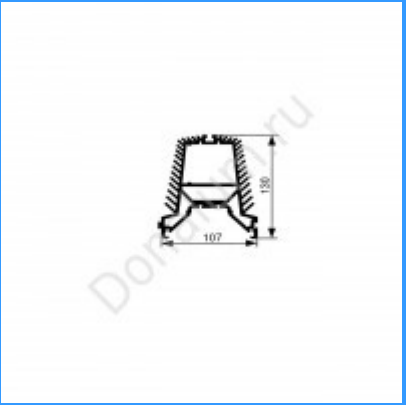
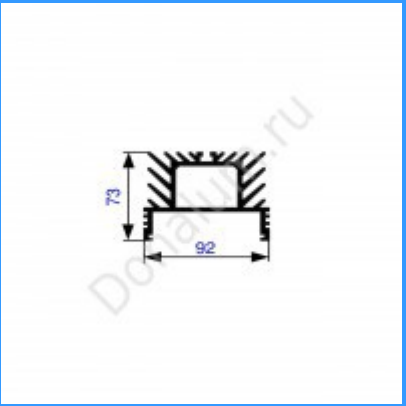
1	11,072	140	 <p>Technical drawing of a circular radiator. The drawing shows a central circular core with radial fins. A dimension line indicates a diameter of 140 mm.</p>	140
2	7,255	151,5	 <p>Technical drawing of a radiator. The drawing shows a rectangular radiator with a central horizontal section. Dimensions are indicated: a height of 130 mm and a width of 107 mm.</p>	130x107
3	3.961	114.8	 <p>Technical drawing of a radiator. The drawing shows a rectangular radiator with a central horizontal section. Dimensions are indicated: a height of 73 mm and a width of 92 mm.</p>	73x92

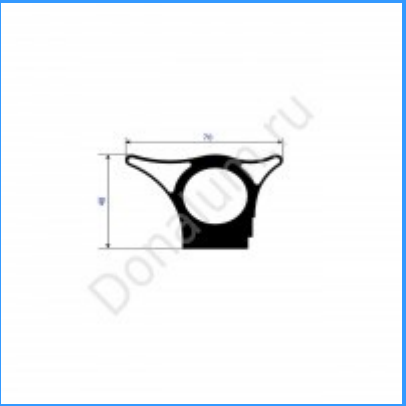
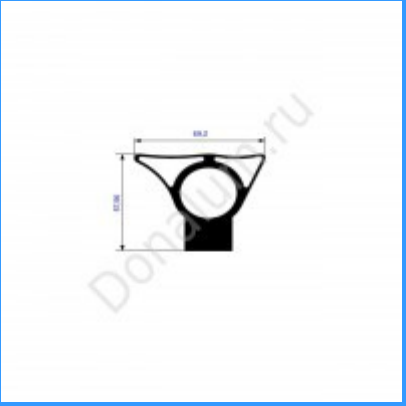
4	2.533	73		48x70
5	2.754	84.5		57.56x69.2
6	2.263	56		54.4x38

7

1.875

56

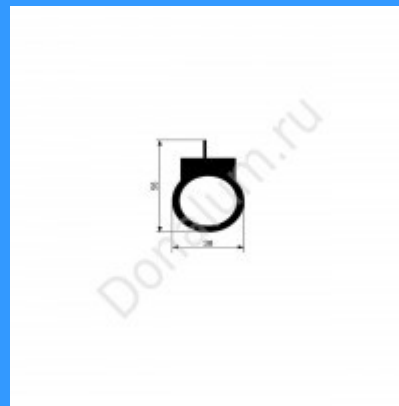

56x38

Радиаторы

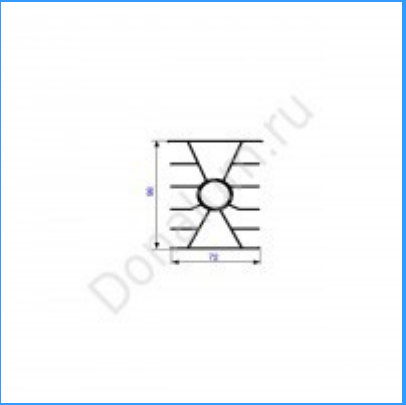
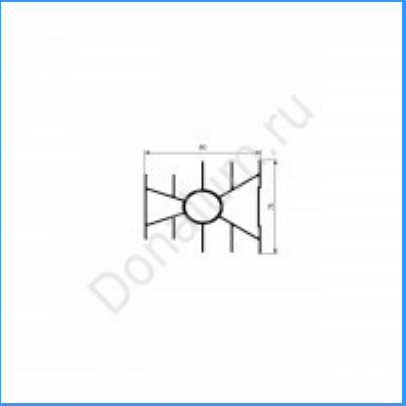
1	2,159	122,5		98x72
2	1.627	103		75x80